

**zelsius®**

## Installation and operating manual

*Electronic compact heat meter*

*M-Bus and 2 inputs/outputs optional*

*Coaxial measuring capsule 2"*

*q<sub>p</sub> 0.6/1.5/2.5 m<sup>3</sup>/h*



## General information

With zelsius® you have acquired one of the most up-to-date, modern heat meters currently available on the market.

Expressive symbols in the display and easy menu navigation make readout simple. It can be operated with one single button. The meter is equipped with a long-life battery made for operation during the initial verification validity period (5 years) including a reserve of at least another year.

### Initial verification

zelsius® is produced and tested in compliance with the new European measuring instruments directive (MID). According to this directive, devices do no longer carry an initial verification stamp, but rather the year of the device's declaration of conformity (recognizable on the front of the device, for example: M07). The MID controls the use of heat meters up to the moment they are placed on the market resp. their first putting into use. After this, the national regulations for devices subject to legal verification apply within the EC.

The duration of initial verification validity in Germany remains 5 years for heat meters. After this period has expired, the measuring device may no longer be used for billing in commercial use. The regulations resp. validity period may vary in other countries of the EC.

### Electro-magnetic interference

zelsius® fulfils the national and international requirements for interference resistance. To avoid malfunctions due to other interferences, do not install fluorescent lamps, switch cabinets or electric devices such as motors or pumps in the immediate vicinity of the meter (minimum distance 1 m). Cables leaving the meter should not be laid parallel to live cables (230V, minimum distance 0.2 m).

### Care instructions

Clean plastic surfaces with a damp cloth only. Do not use any scouring or aggressive cleaning agents!

The device is maintenance-free during the service life. Repairs can only be made by the manufacturer.

### Declaration of Conformity





ZENNER International GmbH & Co. KG declares that this product with the number of the EC type-examination certificate DE-07-MI004-PTB008 complies with the requirements of the EC directives 2004/22/EC (Measuring instruments directive) and 89/336/EEC (electro-magnetic compatibility).

The most up-to-date information about this product can be found at [www.zenner.com](http://www.zenner.com)

## Status display / Error codes

The symbols in the table below show the meter's operational status. The status messages only appear in the main display (energy)!

The temporary display of the warning triangle can be caused by special operating states and does not always mean that the device is malfunctioning. However, should the symbol be displayed over a longer period of time you should contact the service company.

Symbol	Status	Event
	Flow existent	-
	Attention!	Check system / device for errors
	Data transmission	-
	Emergency operation	Exchange device

Error codes show faults detected by zelsius®. If more than one error appears, the sum of the error codes is displayed: Error 1005 = error 1000 and error 5.

Code	Error	Event
1	Hardware error	Exchange device
2	Interruption supply sensor	"
3	Interruption return sensor	"
4	Hardware error	"
5	Short circuit supply sensor	"
6	Short circuit return sensor	"
100	Emergency operation	"
1000	Battery life time exceeded	"
2000	Initial verification expired	"
8001 - 5	Memory error	"

<b>Technical data</b>				
Temperature range calculator	°C	1 – 130		
Temperature range flow sensor	°C	10 – 90		
Temperature difference range	kelvin	3 – 100*		
Temperature sensor type		PT500		
Temperature range sensor	°C	0 – 105 (130)		
Diameter sensors	mm	5.0/DS acc. to EN 1434		
Cable length sensor	m	1.5 (optional 3/5)		
Nominal flow $q_p$	m <sup>3</sup> /h	0.6	1.5	2.5
Maximum flow $q_s$	m <sup>3</sup> /h	1.2	3.0	5.0
Minimum flow $q_i$	l/h	24	60	100
Starting flow horizontal approx.	l/h	4	4	6
Operation pressure PS/PN, max.	bar	16		
Pressure loss at $q_p$	bar	< 0.25		
Display range LCD		8-digit		
Battery	V	3.0 Lithium		
Battery life	years	> 6		
Protection class		IP 54		
Ambient temperature range	°C	5 – 55		
Weight	g	ca. 680		
Mechanical/electro-magnetic class		M1/E1		
Measurement accuracy class		3		

\*Values for symmetrical temperature sensors installation. For other types of installation the values stated on the type plate apply.

## Pulse inputs and outputs (optional)

The pulse value can be called up in the display (see the display overview, Level 1) for devices with two pulse inputs.

The pulse value of the outputs is permanently set and corresponds with the last position of the associated display value.

### Example:

Output 1 = energy output

Energy display = XXXXX.XX MWh

Last position = 0.01 MWh = 10 kWh

Output pulse = 10 kWh

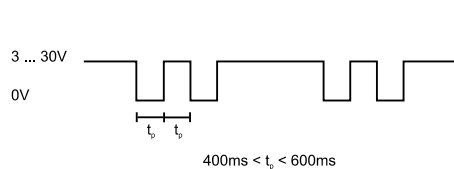

### Technical data I/O

Load	max. 30V DC/20 mA
I/O 1, 2	Open Drain, n-channel FET
Cable	D=4.9mm, 6-core
Pulse-duty factor	1:1 (out); 1:5 (in)
Cable length	1.5 m
Input frequency	max. 1 Hz

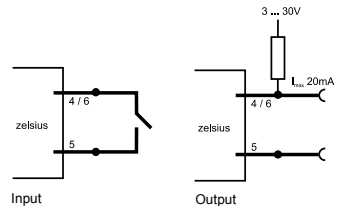

A firmly attached cable is included: external wiring must be done by qualified personnel.

## M-Bus (optional)

The optional M-Bus interface complies with the norm EN 1434-3 and operates with 2400 baud fixed. Both of the cable cores can be connected to the M-Bus network in any order.

Colour	Connection	Meaning
yellow	NC	not connected
pink	M-Bus 1	M-Bus line 1
grey	M-Bus 2	M-Bus line 2
green	I/O 1	I/O 1
white	GND	common ground for I/O 1 and I/O 2
brown	I/O 2	I/O 2

### ZENNER International GmbH & Co. KG

Römerstadt 4  
D-66121 Saarbrücken

Telephone +49 681 99 676-0  
Fax +49 681 99 676-100

E-Mail [info@zenner.com](mailto:info@zenner.com)  
Internet [www.zenner.com](http://www.zenner.com)

## Installation instructions

### General information

The installation of the measuring capsule basically takes place in a single pipe connection piece (EAS) with the connection thread G 2 B and the marking "ZENNER EN 14154 (2005)". The use of transition pieces or adapters is not permissible.

ZENNER recommends to use direct temperature measurement and not to use immersion sleeves. The maximum heating water temperature at the flow sensor may not exceed 90°C. Make sure no heating water escapes during installation – **this can cause burns!**

The current laws and regulations have to be observed, especially EN 1434 part 1+6, (in Germany also AGFW directive FW202 and DIN 4713 part 4 and the initial verification directive).

At devices with M-Bus the general rules of technology and the respective regulations for electrical installations have to be followed. The installation has to be done by qualified professional personnel. Read this instructions carefully right up to the end before starting to mount the device.

### Notes EAS

- Mount ball valves up- and downstream of the EAS.
- Consider the correct installation point (supply or return). Normally this is the return pipe (cooler pipe at heating systems).
- Consider the correct flow direction. This is indicated by an arrow on the side of the EAS. The use of flow direction inverters is forbidden!
- Install horizontally or vertically only, not tilted, inclined or overhead. Installation into horizontal or upstreaming or downstreaming pipelines.
- Do not install at highest point of piping to avoid air inside the flow sensor.
- Consider the dimensions of the heat meter. Axis-centre distance between two EAS 135 mm minimum. Keep about 1 meter distance between zelsius® and electromagnetic sources of interference like switch cabinets, motors or pumps. Keep about 0.2 m distance to power cables. Keep min. 3 cm free mounting space around the device.

### Notes ball valves

- Mount ball valves up- and downstream of the EAS.
- Mount a ball valve with bore M10x1 for direct sensors in the supply. This one is used for mounting the supply sensor.





- Insert the 2 halves of the plastic connector into the sensor's three notches (crimps) and press them together. Use the installation aid as positioning aid. Insert the temperature sensor into the installation point and screw it in tightly until the dead stop of the seal on the 12-point is reached (mounting torque 3-5 Nm).
- Secure the sensor after installation against unauthorised removal with appropriate sealing (available as a sealing set)!

### Putting into use

- Open vales carefully and check installation for leakage.
- While the system is operating, check whether the volume display proceeds and the temperatures displayed correspond with the actual temperatures (see the display overview).
- Wait for the temperature display to be updated (1-2 sec).
- Secure the measuring capsule and the EAS with the enclosed sealing material against unauthorised removal.

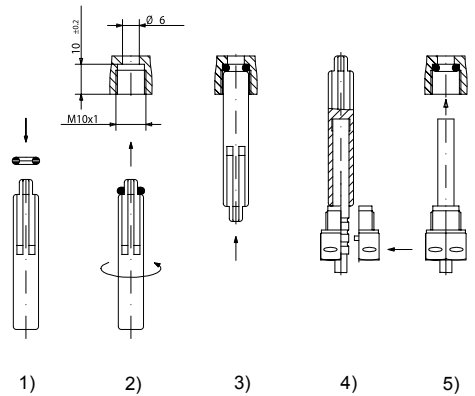

Installation DF-adapter

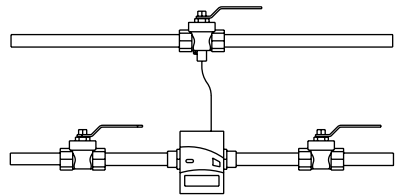

Sensor installation for zelsius® with the return sensor integrated in the measuring capsule



## Level 1

1468375 MWh  
Energy (main display)

c 468375 MWh  
Cooling (optional)

2376.429 m<sup>3</sup>  
Volume

1-000830 m<sup>3</sup>  
Volume external meter 1

2-004070 m<sup>3</sup>  
Volume external meter 2

1888888888 MJ/kWh  
Segment test

87.20°C  
Supply temperature

35.48°C  
Return temperature

5.72°C  
Temperature difference

1370 %h  
Flow rate

283 kW  
Current output



IP 1- 100 l  
Pulse value meter 1

IP 2- 100 l  
Pulse value meter 2

## Level 2

1025.399 MWh  
Heat on S.R.D.

d 0101  
Date of S.R.D.

1-000060 m<sup>3</sup>  
S.R.D. value external meter 1

2-000780 m<sup>3</sup>  
S.R.D. value external meter 2

4036 MWh  
Current monthly consumption

36844590  
Serial number

03024785  
Customer number

You can switch levels at any point in the menu.



## Monthly consumption

010303  
Date Month 1 Energy consumption

010203  
Date Month 2 Energy consumption



## Note

Depending on your meter's model its displays can differ in number and order from those shown here.

You can download a complete and detailed product description in our product area at [www.zenner.com](http://www.zenner.com).

### Level 3

Pe 500r



Sensor type and installation point

It 1300178

Model number

E0C 2010

Initial verification (validity in Germany)

Adr 001

M-bus address

1436

Time

d 170303

Date

Err 5

Error status

CS 0103

Software version



S 2.768 MWh

1st monthly value heat energy

### Legend



Press the button briefly (S) to switch through the display from top to bottom. When you have reached the last menu item the device automatically jumps back to the menu item at the top (loop).



Press the button for about 2 seconds (L), wait for the door symbol to appear (upper right corner of the display) and then release the button. The menu is then updated resp. switches to the sub-menu.



Hold down the button (H) until the device switches to another level or switches back from the sub-menu.